

Instruction Sheet #51-1126
Revised 4-16-02

Copyright©, 2002

by S&S Cycle, Inc.
All rights reserved. Printed in the U.S.A.

S&S Cycle, Inc.

14025 County Highway G Box 215
Viola, Wisconsin 54664

Phone: 608-627-1497 • Fax: 608-627-1488
Technical Service Phone: 608-627-TECH (8324)
Technical Service Email: sstech@sscycycle.com
Website: www.sscycycle.com



Installation Instructions for S&S Big Twin HVHP Oil Pump Kits

SAFE INSTALLATION AND OPERATION RULES:

- Before installing your new S&S oil pump it is your responsibility to read and follow the installation and maintenance procedures in these instructions and follow the basic rules below for your personal safety.
- Gasoline is extremely flammable and explosive under certain conditions and toxic when breathed. Do not smoke. Perform installation in a well ventilated area away from open flames or sparks.
- Compressed air and particles dislodged from using compressed air are harmful to eyes and body. Wear protective goggles when using compressed air and always direct air stream away from body parts such as hands and eyes and other people near you.
- Some solvents, degreasers and other chemicals are harmful to skin, eyes and other body parts. Many items are flammable and present a fire hazard. Read manufacturer's instruction label for proper use. Use in well ventilated area and wear protective clothing when using them to avoid personal injury.
- If motorcycle has been running, wait until engine and exhaust pipes have cooled down to avoid getting burned before performing any installation steps.
- Before performing any installation steps disconnect battery to eliminate potential sparks and inadvertent engagement of starter while working on electrical components.
- Read instructions thoroughly and carefully so all procedures are completely understood before performing any installation steps. Contact S&S with any questions you may have if any steps are unclear or any abnormalities occur during installation or operation of motorcycle with S&S oil pump on it.
- Consult an appropriate authorized H-D service manual for correct disassembly and reassembly procedures for any parts that need to be removed to facilitate installation.
- Use good judgment when performing installation and operating motorcycle. Good judgment begins with a clear head. Don't let alcohol, drugs or fatigue impair your judgment. Start installation when you are fresh.
- For optimum performance and safety and to minimize potential damage to oil pump or other components, use the mounting hardware that is provided and follow all installation instructions.
- Be sure all oil lines, supply and return, are routed correctly with clamps in place and tightened. Lines must not contact exhaust pipes or other extremely hot surfaces where they could melt or leak and catch fire.
- Motorcycle exhaust fumes are toxic and poisonous and must not be breathed. Run motorcycle in a well ventilated area where fumes can dissipate.

IMPORTANT NOTICE:

Statements in this instruction sheet preceded by the following words are of special significance:

WARNING

Means there is the possibility of injury to yourself or others.

CAUTION

Means there is the possibility of damage to the engine or motorcycle.

NOTE

Other information of particular importance has been placed in italic type.

S&S recommends you take special notice of these items.

WARRANTY:

All S&S parts are guaranteed to the original purchaser to be free of manufacturing defects in materials and workmanship for a period of twelve (12) months from the date of purchase. Merchandise that fails to conform to these conditions will be repaired or replaced at S&S's option if the parts are returned to us by the purchaser within the 12 month warranty period or within 10 days thereafter.

In the event warranty service is required, the original purchaser must call or write S&S immediately with the problem. Some problems can be rectified by a telephone call and need no further course of action. A part that is suspect of being defective must not be replaced by a Dealer without prior authorization from S&S. If it is deemed necessary for S&S to make an evaluation to determine whether the part was defective, it must be packaged properly so as to not cause further damage and be returned prepaid to S&S with a copy of the original invoice of purchase and a detailed letter outlining the nature of the problem, how the part was used and the circumstances at the time of failure. If after an evaluation has been made by S&S and the part was found to be defective, repair, replacement or refund will be granted.

ADDITIONAL WARRANTY PROVISIONS:

- (1) S&S shall have no obligation in the event an S&S part is modified by any other person or organization.
- (2) S&S shall have no obligation if an S&S part becomes defective in whole or in part as a result of improper installation, improper maintenance, improper use, abnormal operation or any other misuse or mistreatment of the S&S part.
- (3) S&S shall not be liable for any consequential or incidental damages resulting from the failure of an S&S part, the breach of any warranties, the failure to deliver, delay in delivery, delivery in non-conforming condition or for any other breach of contract or duty between S&S and a customer.
- (4) S&S parts are designed exclusively for use in Harley-Davidson motorcycles. S&S shall have no warranty or liability obligation if an S&S part is used in any other application.

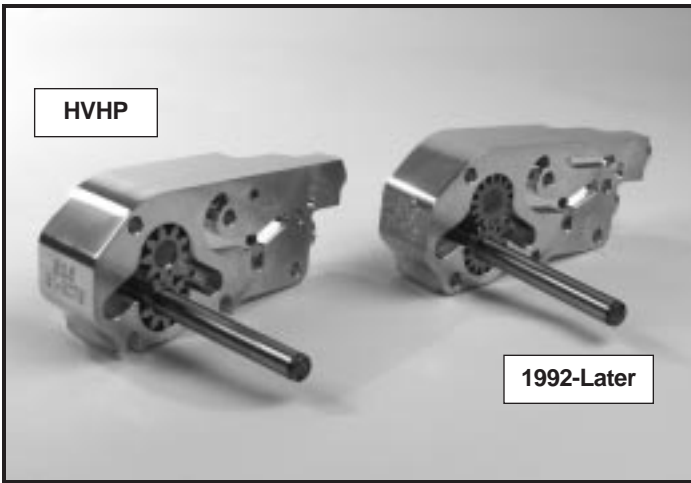

Picture 1

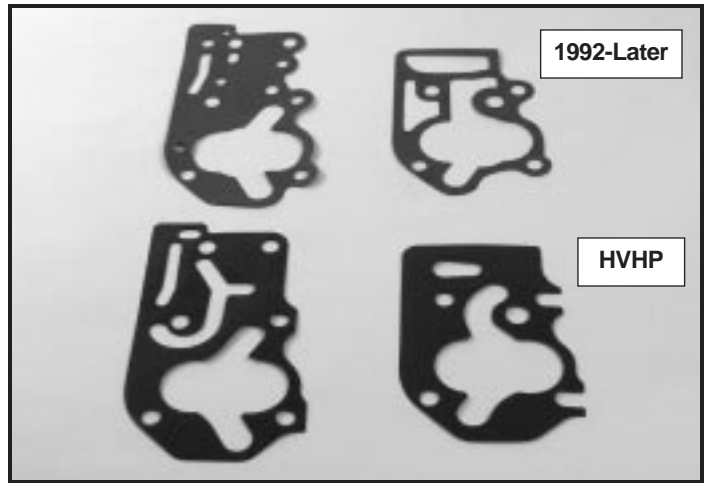

Picture 2

S&S High Volume, High Pressure Oil Pumps

The HVHP oil pumps were introduced by S&S in early 2002. HVHP pumps are similar to previous ones in function but have major machined differences. **See Picture 1.**

1. Part number can be found on bottom surface of oil pump body. In most applications a small mirror can be used to identify part number with engine still in frame.

NOTES:

- HVHP pump kits **DO NOT** use the same gaskets and only use a few other internal parts used in previous kits. **See Picture 2.**
 - HVHP oil pumps provide 38% more oil supply volume. They also increase pressure over 1992 and later OEM H-D pumps. They offer 61% more scavenging than 1992 and later style pumps.
2. Chrome Plating - S&S does not recommend chrome plating oil pump body or cover. Proper preparation for plating requires abrasive buffing compounds which can plug critical passages and otherwise damage oil pump. Also, it is extremely difficult to chrome plate oil pump without altering critical machined surfaces. Chrome in these areas can impair pump's performance by altering critical operating tolerances. In addition, chrome may flake off and cause damage to pump and engine.
 3. Powdercoating - Subjecting heat-treated alloys such as those used in S&S oil pumps, crankcases, cylinders and heads to excessive heat can drastically alter hardness, strength and other important properties. Degree to which these properties are altered depends upon temperatures reached and duration of exposure. When powdercoating or otherwise processing alloy parts, S&S exposes them to a maximum temperature of 370°F for no longer than 20 minutes. Under no circumstances should parts be heated past 400°F. Owner assumes all risk and liability for altering oil pump except to insure correct fit. See following note.
 4. Increased wall thickness of some aftermarket crankcases may interfere with proper installation of oil pump. Procedure for insuring correct fit is described in Installation section.

5. Instructions for HVHP pumps are different from instructions for previous pumps. Refer to S&S Oil Pump Instructions 00-6251 for information on previous pumps. (Instructions can be downloaded at www.sscycle.com; call 608-627-1497 or e-mail sstech@sscycle.com if unable to download instructions from Website.

CAUTION - Plating or otherwise altering S&S oil pump or any component thereof may cause irreversible damage to pump and interfere with engine lubrication. Damages caused by altered oil pump or component will not be covered under warranty.

6. Both the "universal" pump cover 31-6079 and pump cover 31-6094 have the 1992-later style mounting bolt pattern and feed and return holes. "Univeral" pump cover 31-6079 has additional locations for feed and return holes at top of cover. **See Picture 3.**
7. Oil pump covers are described in more detail in "Oil pump cover assembly" section.

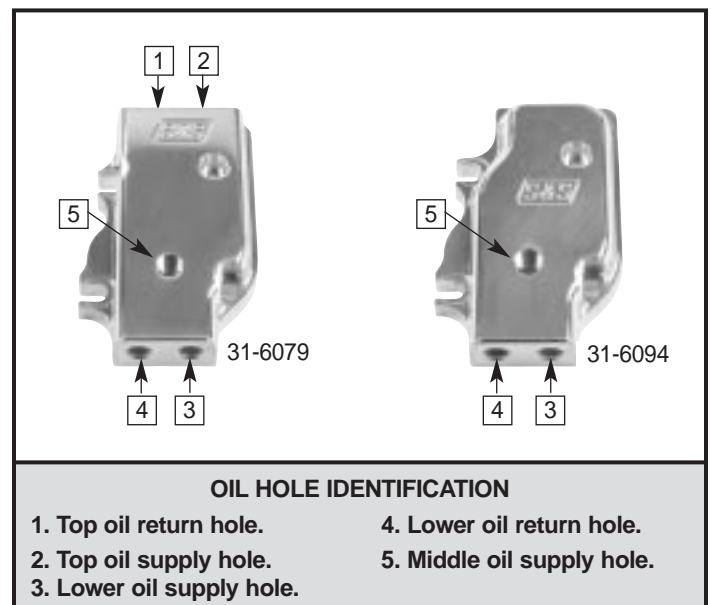

Picture 3

CAUTION - Bottom-mount oil supply line fitting is not recommended for Dynas, Road Kings, or other models with oil tank below transmission because of possibility of cavitation or "air lock" occurring during oil changes.

NOTES:

- Only one supply and one return hole will be used.
- #31-6302 and #31-6298 oil pump kits include oil pump drive shaft gear, pinion shaft oil pump drive gear and breather gear kit w/shims.

CAUTION -Metal filings, dirt and other foreign matter can cause extensive damage to oil pump and engine.

WARNING - Compressed air and particles dislodged by compressed air are potentially harmful. Wear protective goggles when using compressed air and always direct air stream away from yourself and others nearby.

Introduction

Read instructions completely and become thoroughly familiar with entire installation procedure before starting.

All S&S HVHP oil pump kits fit only crankcases machined for 1992-later pumps.

CAUTION - Failure to perform all required steps may result in engine damage.

A. Disassembly and crankcase identification. All years.

1. Remove old oil pump, loosen pushrods, remove cam cover, cam and pinion shaft hardware from gearcase.

NOTES:

- S&S has used 1991-earlier and 1992-later style mounting bolt pattern in S&S Evolution style Long Blocks. Confirm pattern prior to ordering HVHP pump body or cover. HVHP pumps fit only 1992-later patterns.
 - Oil pump gasket of known year can be used to positively identify mounting bolt pattern.
 - Machining of some aftermarket crankcases may not be consistent with a specific year group. If in doubt about modifications required for aftermarket crankcase, contact crankcase manufacturer.
 - S&S cases have either a two or three letter code stamped above either the rear engine mount surface or above oil pump mounting surface. The first letter designates oil pump year/style machining. "A" means the case has 1991-earlier machining, "B" indicates the case has 1992-later machining.
2. Confirm that adequate clearance exists between new oil pump body and crankcase by temporarily installing pump assembly on crankcase and inspecting areas indicated in photo. **See Picture 5.** In some instances it may be necessary to remove small amount of material from pump body to obtain correct fit.

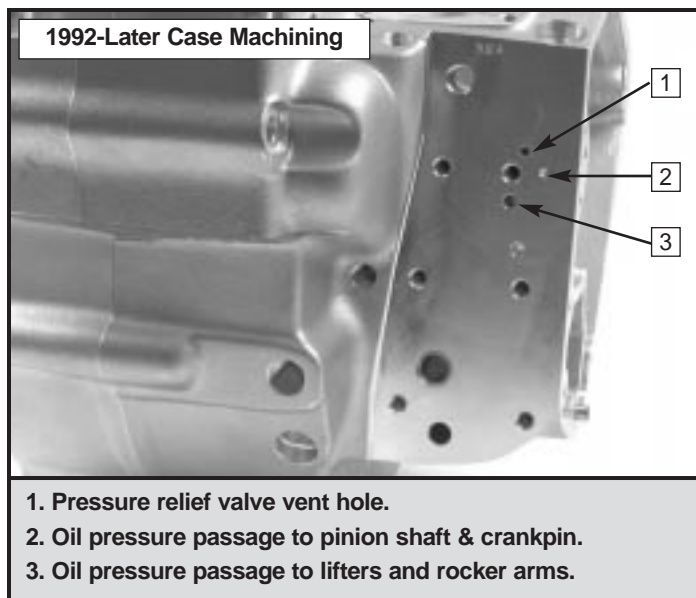

Picture 4

NOTES:

- If modification of pump body is necessary, remove minimum amount of material required to properly position oil pump on crankcase. Take special care not to damage gasket surfaces. After modification, clean pump body thoroughly with suitable parts cleaner and compressed air to remove metal filings generated during procedure. Remove all traces of solvent prior to installation.
- S&S crankcases require no modification for S&S oil pump.

CAUTIONS:

- Failure to clean oil pump before engine assembly may result in engine damage.
- Improper oil pump installation due to incorrect identification of crankcase year group may result in engine damage.

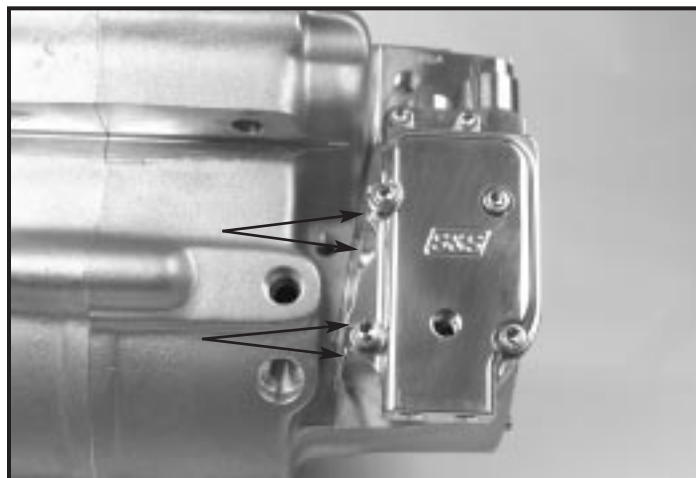

B. Oil pump cover assembly.

1. Universal oil pump cover #31-6079 has supply and return holes at top of cover similar to 1991-earlier pump covers. Cover #31-6094 plumbs the same as stock 1992-later.
 - a. First step in cover assembly is to identify cover and insure that cover is correct for application.
 - b. Customer must then install oil line fittings and other required hardware, if applicable, in cover.
 - c. All covers require fittings for supply and return lines. Cover #31-6079 offers more than one location for supply and/or return line fittings.
 - d. Customer must decide which holes in cover will be used and block off holes not used with supplied pipe plugs. Correct identification of locations for supply and return fittings is critical.

CAUTION - Incorrect placement of oil lines or oil line fittings can cause extensive engine damage not covered under warranty. See Appendix (Page 7) for correct routing of oil pump lines.

NOTES:

- Covers #31-6079 and #31-6094 are compatible with rigid OEM oil return and supply lines found on 1992-up models. In these applications, hole #5 in face of cover is used for supply line. Hole#4 in bottom left location is used for return line. (See Picture 3.)
- After installing elbow fitting #50-8114 for return line, customer must install compression fitting #50-8120 (supplied in kit) in elbow rather than conventional hose fitting #50-8115. Fitting #50-8115 will be used for supply line fitting. For use with OEM rigid oil lines, return fitting must face forward, toward front of engine. Supply fitting will face downward at approximate 45° angle toward lower left corner of pump cover.

CAUTIONS:

- Always apply Teflon tape or pipe sealant such as Loctite PST to threads of fittings before assembling fittings or installing fittings in cover. Failure to install fittings correctly may damage cover and void warranty.
 - Apply tape or pipe sealant to threads only. Avoid using excessive amounts that may protrude into and obstruct oil passages or contaminate engine oil. Incorrect use of Teflon tape or pipe sealant may cause engine damage not covered under warranty.
2. Cover #31-6079 - Fittings for oil supply and return lines can be placed in holes at either bottom or top of cover according to installer's requirements.
 - a. Preparation - Apply Teflon tape or pipe sealant such as Loctite PST to threads of fittings and elbows to be used. If 1992-up OEM rigid return line is used, substitute compression fitting for 1 hose fitting. Hole #4 must be used for 1992-up OEM rigid return line. (See Picture 3.)
 - b. Install hose fittings in elbows. Install compression fitting #50-8120 in return hole fitting #4 if 1992-up OEM rigid return line is used. Compression fitting must face forward for use with OEM rigid return line.

3. Cover #31-6079 is often referred to as S&S "universal" cover. It is supplied on S&S Long Blocks unless customer specifies otherwise at time of order. Universal cover is compatible with OEM rigid supply and return lines used on 1992-up models. Fittings for oil supply and return lines can be placed in holes at either bottom or top of cover as required by purchaser. Fitting for main oil supply line can also be installed in hole in face of cover if desired.

NOTE - If OEM rigid oil lines are used, return fitting must face forward, toward front of engine. Supply fitting will face downward at approximate 45° angle toward lower left corner of pump cover.

C. Inspection

S&S oil pump bodies, covers and gaskets may appear similar to other manufacturer's products but should not be interchanged due to possible differences that could impair oil pump function.

CAUTION - Using oil pump components other than those provided by S&S may result in oil leak, insufficient oil pressure and possible engine damage.

WARNINGS:

- Many solvents are flammable and potentially toxic. Read solvent manufacturer's instructions prior to use.
- Compressed air is potentially harmful, especially to eyes and skin. Wear goggles and other protective clothing during use, and direct air stream away from yourself and others nearby.

1. Disassemble, clean, and inspect oil pump.
2. Inspect gaskets for loose bits of material that could dislodge and block oil passages.
3. Lightly oil relief plunger, check ball, springs, and assemble into their respective positions in the body, leaving check ball cap loose for priming purposes in later steps.
4. For installation of pump with engine on work bench. See Step D.
5. For installation of pump with engine in frame using existing pump drive shaft. See Step E.

D. Installation of pump. (Engine out of frame.)

1. Assemble pump back into the configuration in which it was received.

NOTE - A dab of Hylomar or other thin gasket sealer in corners of gasket may be used to hold gasket in place if care is taken to avoid critical areas such as oil passages and interior of oil pump. Otherwise, gaskets should be installed dry.

CAUTION - Gasket sealant may interfere with engine lubrication if allowed to enter oil pump or passages machined in crankcase. Damage related to improper use of gasket sealant will not be covered under warranty.

2. Position pump body gasket onto crankcase with a dab of sealer.
3. Apply engine oil that is going to be used in the engine to oil pump gears, driveshaft and driveshaft bushing in crankcase.

4. Install oil pump in crankcase in normal fashion placing pump drive gear over driveshaft as shaft is passed through bushing and into crankcase gear compartment. Slide pump assembly into place and install top two mounting bolts and washers loosely.
5. Turn pump to align keyway in shaft and drive gear. Install the driveshaft key and snap ring inside the gearcase.

*NOTE - Insure that drive shaft key and snap ring are installed properly. If snap ring is installed incorrectly, sprung or otherwise damaged, it may become dislodged or allow gear key to come out. **Picture 6 and Picture 7.***

CAUTION - Loss of oil pump drive gear snap ring or key will result in disengagement of oil pump causing loss of oil pressure and possible engine damage.

6. Proceed to Step F.

E. Installation of pump. (Engine in frame.)

With engine in frame, the pump driveshaft cannot be removed. The HVHP pump can be installed without removing the driveshaft from the crankcases. The existing driveshaft in the cases will work with the HVHP pump.

NOTE - A dab of Hylomar or other thin gasket sealer in corners of gasket may be used to hold gasket in place if care is taken to avoid critical areas such as oil passages and interior of oil pump. Otherwise, gaskets should be installed dry.

CAUTION - Gasket sealant may interfere with engine lubrication if allowed to enter oil pump or passages machined in crankcase. Damage related to improper use of gasket sealant will not be covered under warranty.

1. Position pump body gasket onto crankcase with a dab of sealer.
2. Prelube the return gears.
3. Install the return side key and drive gear onto the pump drive shaft.
4. Install the return side idler gear into the pump body.

5. Push the driveshaft in toward the gearcase as far as it will go while holding driveshaft gear in gearcase in place so shaft goes through it.
6. Install pump body assembly onto the driveshaft, turn return idler gear as needed to get return gear teeth to mesh, slide pump assembly into place and install top two mounting bolts and washers loosely.
7. Now push driveshaft from gear case end back as far as it will go towards the transmission, rotating shaft so keyway is accessible..
8. Install the feed side drive gear onto the driveshaft with counterbore facing the transmission. Slide gear all the way in until it bottoms in the gear pocket. This will leave the drive shaft protruding from the gear with the keyway and snap ring groove exposed. Install the feed gear key. This key is smaller than the standard oil pump drive keys used on previous S&S oil pumps. Tweezers or small needle nose pliers will make for easier key installation. After the key is installed, install the "c" shaped retaining ring into the ring groove. Now push the driveshaft forward towards the gear case making sure it passes through the driveshaft gear in the gearcase. Turn pump to align keyway in shaft and drive gear. Install the driveshaft key and snap ring inside the gearcase.

*NOTE - Insure that drive shaft key and snap ring are installed properly. If snap ring is installed incorrectly, sprung or otherwise damaged, it may become dislodged or allow gear key to come out. **Picture 6 and Picture 7.***

CAUTION - Loss of oil pump drive gear snap ring or key will result in disengagement of oil pump causing loss of oil pressure and possible engine damage.

9. Proceed to Step F.

F. Installation of cover.

NOTE - A dab of Hylomar or other thin gasket sealer in corners of gasket may be used to hold gasket in place if care is taken to avoid critical areas such as oil passages and interior of oil pump. Otherwise, gaskets should be installed dry.

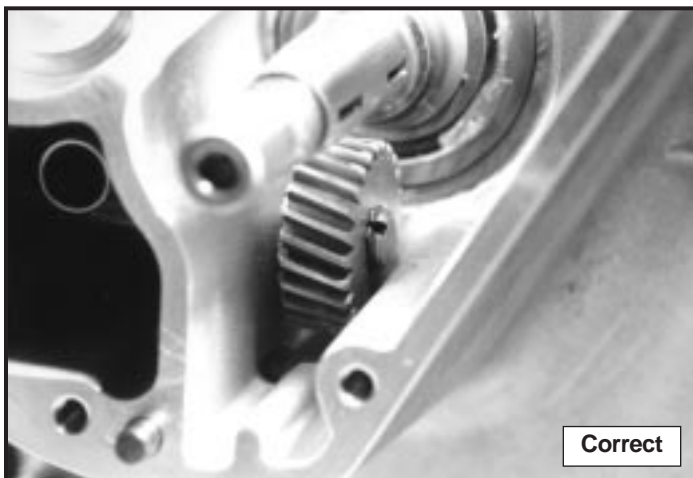

Picture 6

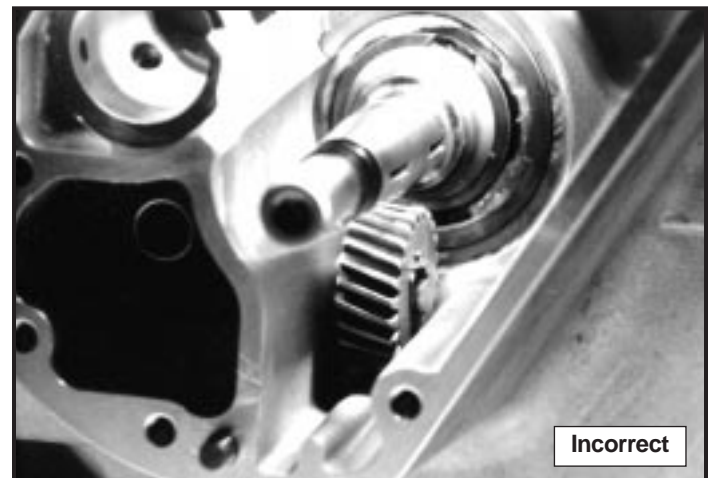

Picture 7

CAUTION - Gasket sealant may interfere with engine lubrication if allowed to enter oil pump or passages machined in crankcase. Damage related to improper use of gasket sealant will not be covered under warranty.

1. Position pump cover gasket onto pump body with a dab of sealer.
2. Install the two inboard mounting bolts with washers through the pump cover gasket and pump body, and start by a thread or two.
3. Install the pump cover, two outboard bolts with washers, but do not tighten at this time.
4. Perform the free spin procedure.
 - a. While continually turning oil pump drive gear in gearcase to check pump for binding, gradually tighten cover bolts in an X-pattern to a final torque of 90-120 in-lbs, leaving the top two pump body bolts loose. If pump binds, loosen cover screws and shift pump slightly while rotating gears. Retighten cover bolts while turning driveshaft to confirm bind-free pump operation. Pump should operate smoothly when correctly aligned on crankcase.
 - b. Evenly tighten two remaining bolts to 90-110 in-lbs. If remaining bolts are inaccessible with torque wrench due to oil line fittings, temporarily remove fittings or carefully tighten bolts with thin box-end wrench.

NOTE - Oil pump failure may result if an attempt to bypass the "free spin" procedure is made. The pump can be changed if you do not remove the pinion shaft hardware but you cannot check for pump free spin. If this procedure is not performed, pump failure may result and the part will no longer be covered under warranty.

CAUTION - Failure to correct bind may result in damage to oil pump or other engine parts.

G. Priming the oil pump.

Priming the oil pump will generally fall into one of three categories:

1. Engine on bench.

The engine is to be delivered to a customer or installed at a later date. Priming the pump on the bench will minimize the time spent priming the pump after engine is installed.

 - a. Remove cap, spring, and check ball from oil pump.
 - b. Attach a piece of clear tubing approximately 12" long to the supply fitting on pump cover. Hold tubing vertically and fill with same type of oil to be used in engine.
 - c. Using thumb, rotate pump drive shaft gear in normal direction of rotation. (Top of gear is moved towards right side of engine.)
 - d. Rotate shaft (refilling tubing as necessary) until no air bubbles can be seen in the oil exiting the check ball cavity.
 - e. When pump is primed, re-install the check ball, spring, and cap. Place protective cap over supply fitting.

2. Engine in frame.

Oil tank above the oil pump.

 - a. Connect oil lines as required. (See Appendix on oil line routing if necessary.) Fill oil tank.
 - b. Remove cap, spring, and check ball from oil pump.
 - c. Rotate pump drive shaft gear (top of gear is moved towards right side of engine) until air-free oil can be seen exiting from check ball cavity.
 - d. When pump is primed, replace check ball, spring, and cap.

NOTE - This procedure can be performed even if engine is fully assembled. Pump rotation will be achieved by removing spark plugs and cranking engine over with kick or electric starter.

3. Engine in frame.

Oil tank below the oil pump.

 - a. Connect oil lines as required. (See Appendix on oil line routing if necessary.) Fill oil tank.
 - b. Remove cap, spring, and check ball from oil pump.
 - c. Fill check ball cavity with oil and observe the rate at which it drains away. Re-fill cavity as necessary until the slowest drain down rate is achieved.
 - d. When drain down rate has stabilized, fill check ball cavity one last time, then install check ball, spring, and cap.

NOTE - This procedure can be performed on assembled engine if oil pump happens to lose prime after an oil change.

CAUTION: - "Air lock" or cavitation can occur if trapped air is not released from oil pump after installation. It can occur with new pump as well as used pump that has been removed from engine, and interferes with oil circulation. It is installer's responsibility to remove trapped air by priming pump prior to running engine and to confirm correct pump operation with engine running.

- H. Assemble gearcase.
 1. Install the previously removed pinion shaft components according to the standard procedure for the appropriate year group. Year groups applicable to the pinion shaft components are as follows:
 - a. 1990-'92 OEM Harley-Davidson
 - b. 1993-'99 OEM Harley-Davidson
 - c. All S&S Big Twin with 1992-up style crankcase.

NOTE - S&S supplies only the 1954-'89 style pinion shaft oil pump drive gear in its production V² Big Twins. This gear must be installed with the chamfer towards the shoulder on pinion shaft.

CAUTION - Installing pinion shaft oil pump drive gear backwards on pinion shaft may cause stress riser resulting in eventual failure of shaft. Damage caused by incorrect installation of gear or other parts is not covered under warranty.

I. Initial startup and post-operation checks. All years.

1. After pump has been installed and primed, oil lines connected in correct manner (See Appendix on page 7.) and oil tank filled to correct level, confirm oil circulation with oil pressure gauge and by removing cap from oil tank and observing oil return to tank. If oil is not seen returning to tank, S&S recommends removing return line from tank and placing end in drain pan to confirm oil circulation.

NOTE - Engine oil circulates under pressure. Areas exposed to escaping oil should be covered with rags and engine turned off immediately after oil circulation is confirmed to minimize oil loss.

WARNING - Oil on tires or brakes can cause loss of control of motorcycle resulting in serious injury to operator and others.

2. After confirming oil circulation, run engine for several minutes and check for leaks.

NOTES:

- *Low oil pressure is often blamed on oil pump when actual cause is worn bushings or another internal component. A new oil pump will not correct problems caused by worn parts and excessive operating clearances. If low oil pressure exists after new oil pump is installed, check clearances and other possible causes such as installation of different gear cover, tappet guides, etc.*
- *Sudden clatter in previously quiet hydraulic lifter may indicate lifter failure OR excessively low oil pressure and should be investigated. It is not unusual for hydraulic lifters to clatter when a new or recently rebuilt engine is first started, but noise should disappear as lifters pump up. Time required depends on several factors including brand of lifter, oil viscosity and temperature.*

NOTE - All S&S 1992-later style cases and most 1992-earlier H-D crankcases have provision in rear of cam-side crankcase for two pipe-thread fittings. Fitting above the oil pump is for vent line from oil tank. The bottom hole is used as crankcase breather on 1992-earlier models and on S&S Long Blocks set up for crankcase breathing or combination crankcase-cylinder head breathing. Engine must have 1992-earlier style cam cover and gasket for crankcase breathing; otherwise, large oil losses will occur out the bottom hole. The vent fitting will be used in all applications. The bottom hole will be used in most "crankcase breather" situations. Any crankcase breather hole not used must be blocked.

J. Removing pump for service.

1. Disconnect oil lines
2. Loosen pushrods
3. Remove gear cover
4. Remove cam
5. Remove pinion shaft hardware
6. Remove oil pump drive shaft gear retaining ring
7. Remove oil pump cover
8. Push pump drive shaft towards transmission to gain access to retaining ring and key, remove retaining ring/key.
9. Remove feed gears
10. Remove remaining pump bolts and remove pump assembly from drive shaft

Appendix: Oil Line Routing

Most Big Twin oiling systems utilize three oil circuits: supply, return and vent.

- Supply circuit delivers oil from tank to supply fitting of oil pump cover. **See Picture 3.** In motorcycles with oil tank located above transmission, supply fitting in oil tank is almost always located on bottom of tank at center or rear. In Dynas, Road Kings, and other models with oil tank below transmission, supply line exits oil tank on bottom of primary drive side, then crosses to cam side and connects with supply fitting on oil pump cover.

To distinguish oil tank 's supply fitting from vent and return fittings, remove oil lines and pour small amount of oil into tank. With motorcycle in upright position, oil will flow out supply line fitting.

- Return circuit delivers oil from return fitting in oil pump cover, **see Picture 3**, through oil filter and cooler (if applicable), to return fitting in oil tank.

In horseshoe-type oil tanks used on Softails, OEM rigid frames and many custom applications, two fittings nearest front of oil tank are identical. Fittings may enter through upper area of tank or connect to fittings near bottom that are attached to standpipes inside tank. These fittings are for oil return and vent lines and in most cases may be used interchangeably. Main exception is with oil tanks with "in tank" oil filter.

In Dynas, Road Kings, and other models with oil tank located below transmission, return fitting is on top of oil tank nearest center of motorcycle. Vent fitting is beside return fitting.

- Vent circuit equalizes pressure between oil tank and crankcase. See preceding paragraph for location of vent fitting in oil tank. Vent line runs from vent fitting on oil tank to fitting in crankcase located above the oil pump.

Replacement Parts for S&S High Volume, High Pressure Oil Pumps

- | | | |
|--|---|---|
| <p>1. Pump body assembly
Fits 1992-'99 V²31-6078</p> <p>2. Shaft, idler31-6080</p> <p>3. Seal, drive shaft31-6064</p> <p>4. Gear, return drive, HVHP .. 31-6075</p> <p>5. Gear, return idler, HVHP.... 31-6083</p> <p>6. Gear, supply drive, HVHP . 31-6074</p> <p>7. Gear, supply idler, HVHP31-6081</p> <p>8. Shaft, drive (HD#26346-70)31-6011</p> <p>9. Key, drive shaft.....50-8228</p> <p>10. Plug, 1/8"-27 (HD#45830-48).....50-8331</p> <p>11. Ball, check valve (HD#8866 & 8873)
.....50-8091</p> <p>12. Spring, check valve (HD#26262-80)
(10 Pack)31-6092</p> <p>13. Relief valve31-6082</p> <p>14. Spring, relief valve (HD#26207-83)
(10 Pack)31-6084</p> <p>15. Screw, check valve & relief valve
cover (HD#26263-80).....31-6021</p> <p>16. O-ring (HD#11105)
(10 Pack)50-8078</p> <p>17. Pump cover assembly, 1992-'99
Universal31-6079
Standard (N/S)31-6094</p> <p>18. Elbow, supply/return (HD#26338-68)
.....50-8114</p> | <p>19. Fitting, supply/return hose
(HD#63533-41).....50-8115</p> <p>20. Return fitting, compression
(HD#63523-92)50-8120</p> <p>21. Seal, tubing 3/8" x 1/2" OD x 1/4" Viton
.....50-8271</p> <p>22. Screws, mounting (SHCS)
1/4"-20 x 2 1/2" (10 Pack)50-0212
1/4"-20 x 1 1/2" (10 Pack)50-0224</p> <p>23. Washer, 1/4" (10 Pack)50-7013</p> <p>24. Retaining ring (HD#26348-36)
(10 Pack)50-8106</p> <p>25. Retaining ring, external (HD#11002)
(10 Pack)50-8107</p> <p>26. Gear, pump drive, 24T (HD#26345-73)
.....33-4230</p> <p>27. Gear, pinion shaft pump drive 1954-'89
(HD#26349-73, #26349-73A, 26349-84)
.....33-4232</p> <p>28. Gear, steel breather valve
1977-up Standard size
Gear only33-4241
Gear and shims33-4259
1977-up +.030" oversize
Gear only33-4242
Gear and shims33-4260</p> | <p>29. Shim, steel breather
.100"33-4200
.110" (HD#25320-79)33-4201
.120" (HD#25322-79).....33-4202
.130" (HD#25325-79).....33-4203
.140" (HD#25327-79).....33-4204
.150"33-4205
.160"33-4206
.170"33-4207</p> <p>30. Gasket, pump body 1992-'99 HVHP
(10 Pack)31-6090</p> <p>31. Gasket, pump cover 1992-'99
HVHP (10 Pack).....31-6091</p> <p>32. Gasket rebuild kit (Not shown.)
Includes key and retaining ring.
1992-'99 BT HVHP31-6299</p> <p>33. Master rebuild kit (Not shown.)
Includes gasket rebuild kit, seal,
retaining ring, relief valve spring,
check valve spring, check valve,
ball, and cover screw o-rings.
1992-'99 BT HVHP31-6300</p> |
|--|---|---|

